

Detaildarstellung mit optionaler Randblende

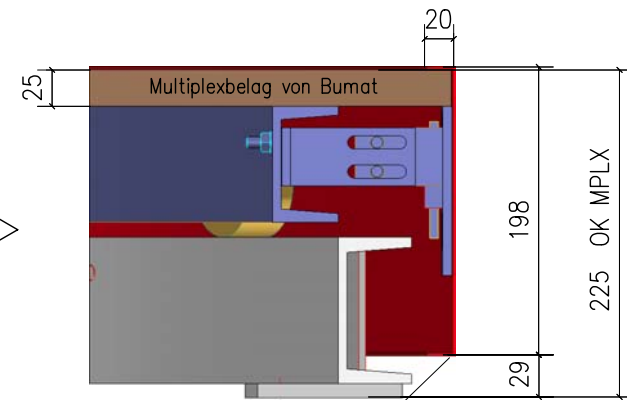

Blende höhenverstellbar +17mm

Befestigung mit Schrauben DIN 921

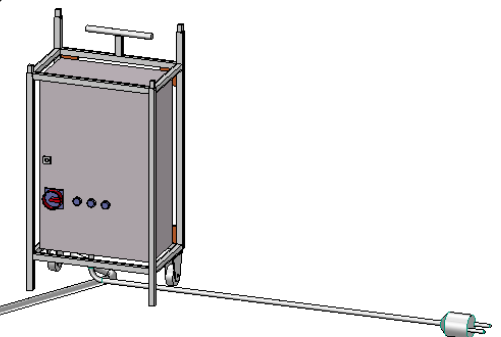
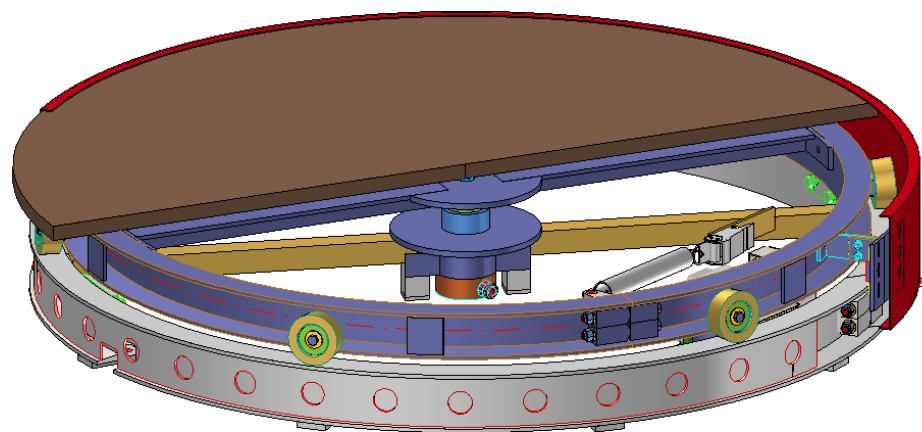

400V / 16A Standard  
 230V / 50Hz optional

Drehscheibe Typ DR 15/10

Bumat Bewegungssysteme GmbH  
 Pfälzer Ring 30  
 D-68766 Hockenheim

Tel.: +49 (0) 6205.9413-30  
 Fax: +49 (0) 6205.9413-55  
 info@bumat.com  
 www.bumat.com

