

Detaildarstellung mit optionaler Randblende

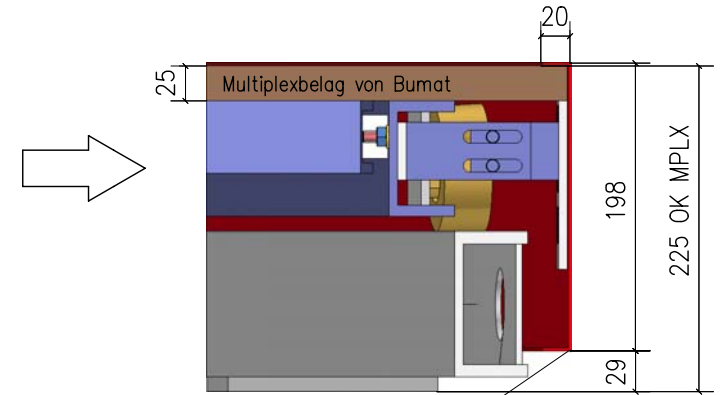

Blende höhenverstellbar +17mm  
Befestigung mit Schrauben DIN 921

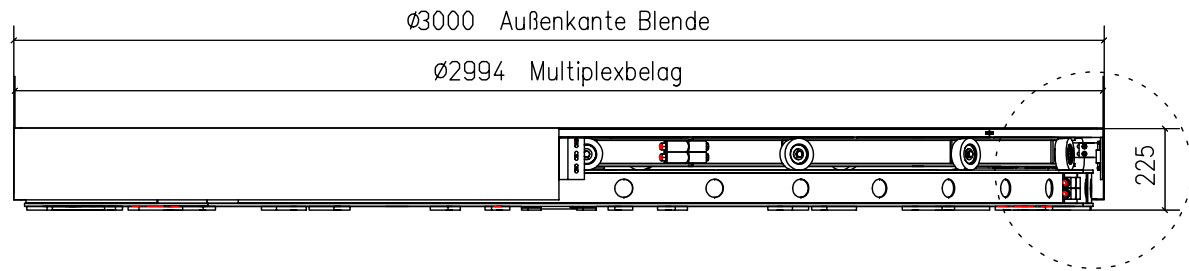
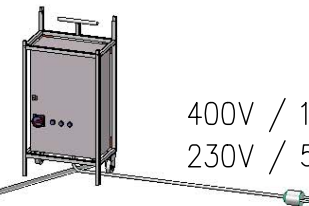
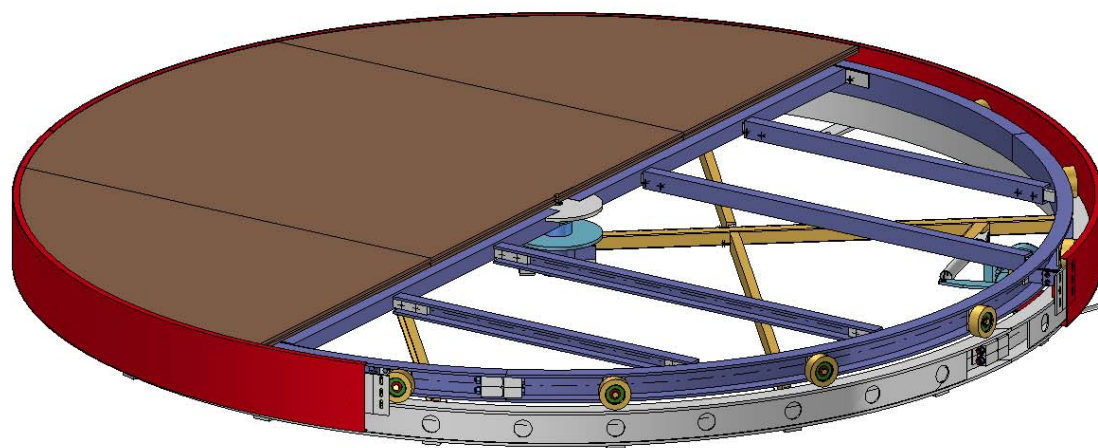

400V / 16A Standard  
230V / 50Hz optional

Drehscheibe Typ DR 30/10

Bumat Bewegungssysteme GmbH  
Pfälzer Ring 30  
D-68766 Hockenheim

Tel.: +49 (0) 6205.9413-30  
Fax: +49 (0) 6205.9413-55  
info@bumat.com  
www.bumat.com

