

**Inkl. Randblende**

Ø4000

Ø3994 (Multiplex)

Blende  
höhenverstellbar

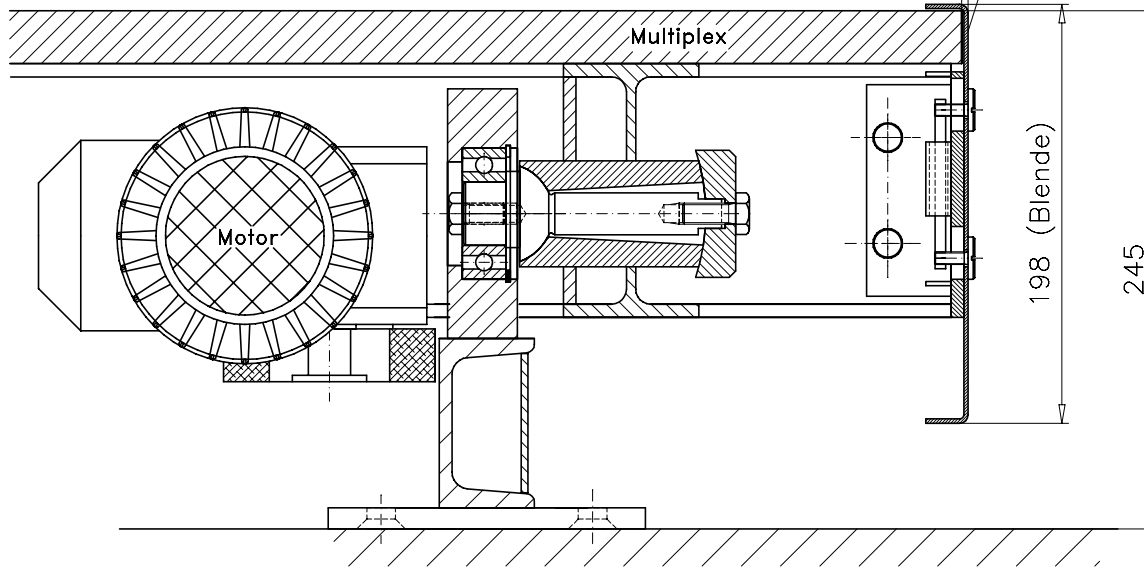

**ohne Randblende**

Ø3994 (Multiplex)

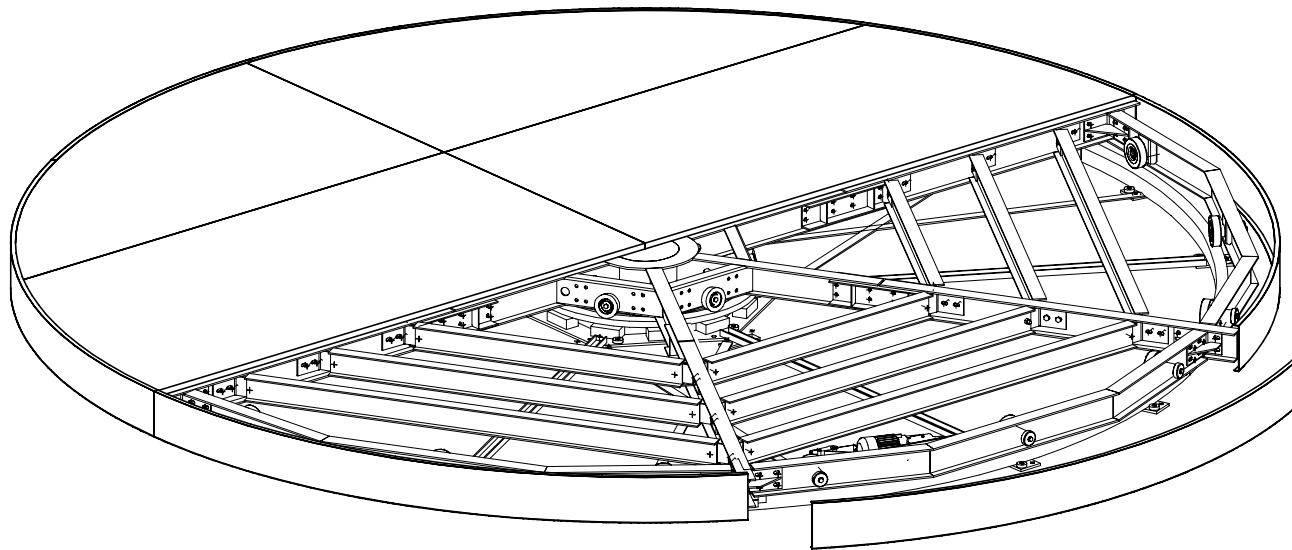
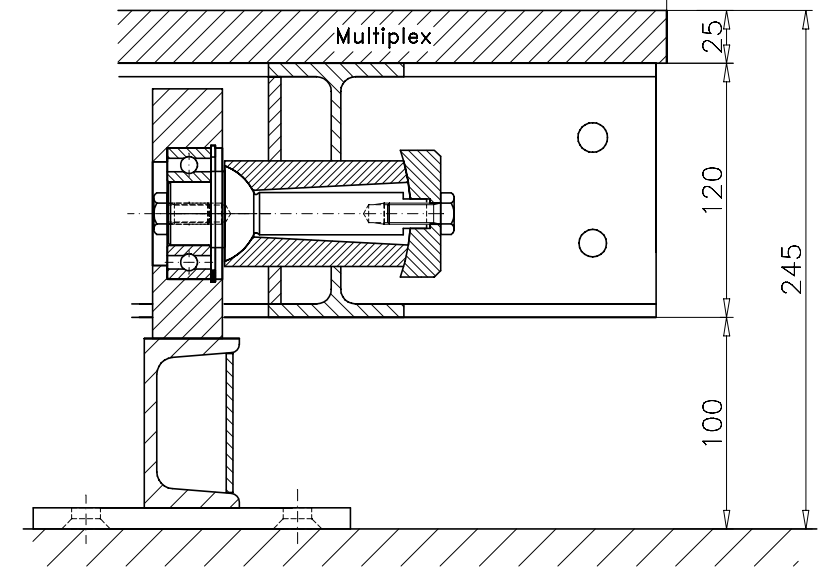

Drehscheibe Typ DSMA 40/35-6

Bumat Bewegungssysteme GmbH  
Pfälzer Ring 30  
D-68766 Hockenheim

Tel.: +49 (0) 6205.9413-30  
Fax: +49 (0) 6205.9413-55  
info@bumat.com  
www.bumat.com

